

# Rodeo Solo™ - Dimensional Diagrams

## Fixture Profile

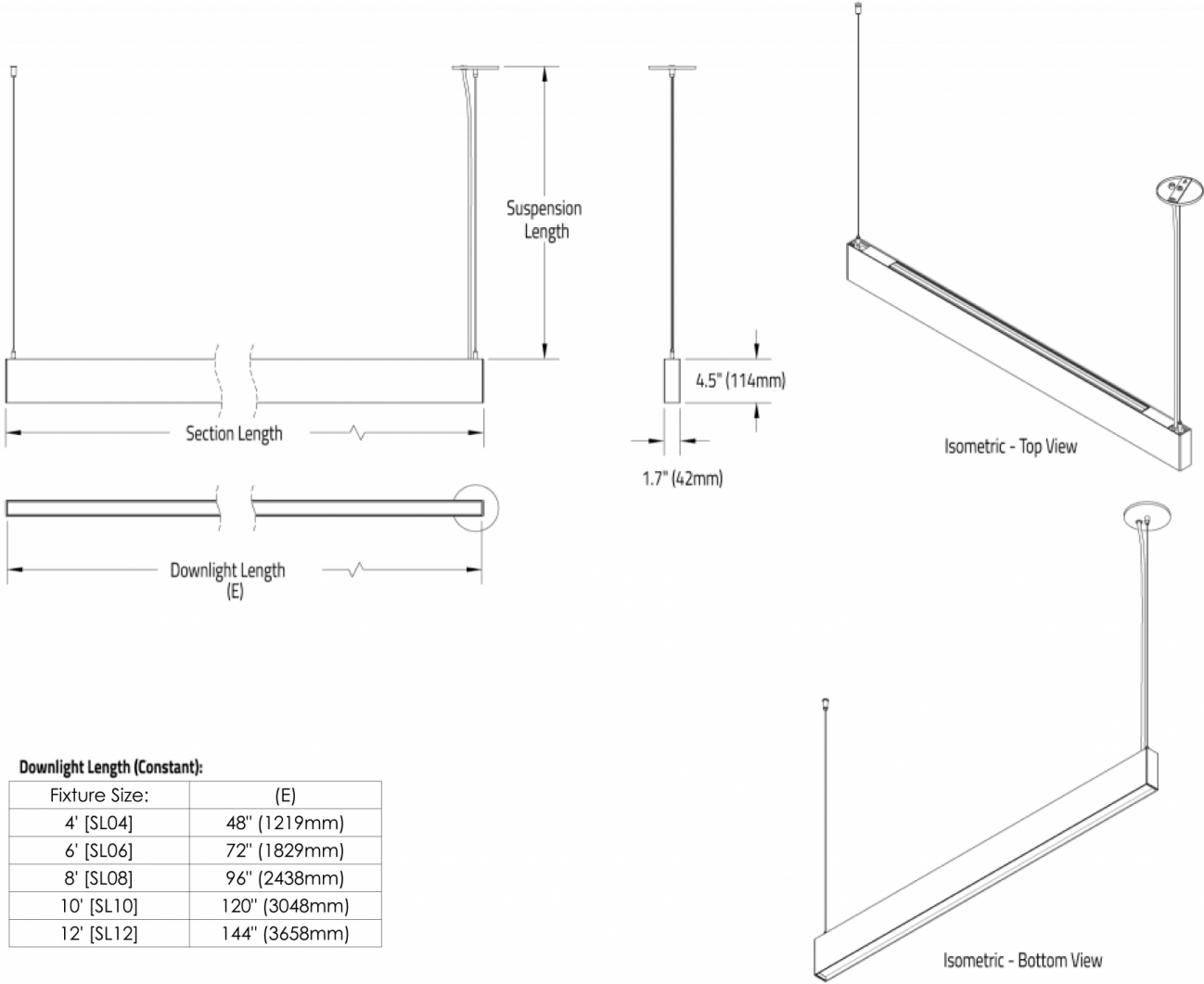

**Downlight Length (Constant):**

| Fixture Size: | (E)           |
|---------------|---------------|
| 4' [SL04]     | 48" (1219mm)  |
| 6' [SL06]     | 72" (1829mm)  |
| 8' [SL08]     | 96" (2438mm)  |
| 10' [SL10]    | 120" (3048mm) |
| 12' [SL12]    | 144" (3658mm) |

# Rodeo Solo™ - Dimensional Diagrams

## Sections

### Standalone:

Standalone (SLS1) - End cap on both sides:

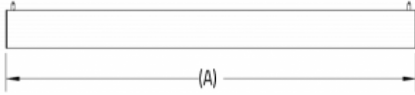

### Section Length:

| Fixture Size: | Standalone [SLS1] (A) | Start [SLS2] (B) | Middle [SLS3] (C) | End [SLS4] (D)  |
|---------------|-----------------------|------------------|-------------------|-----------------|
| 4' [SL04]     | 48.2" (1224mm)        | 47.2" (1199mm)   | 47.9" (1217mm)    | 48.9" (1242mm)  |
| 6' [SL06]     | 72.0" (1778mm)        | 71.0" (1803mm)   | 71.7" (1821mm)    | 72.7" (1847mm)  |
| 8' [SL08]     | 95.9" (2436mm)        | 94.8" (2408mm)   | 95.5" (2426mm)    | 96.5" (2451mm)  |
| 10' [SL10]    | 119.7" (3040mm)       | 118.7" (3015mm)  | 119.4" (3033mm)   | 120.4" (3058mm) |
| 12' [SL12]    | 143.6" (3647mm)       | 142.5" (3620mm)  | 143.2" (3637mm)   | 144.2" (3663mm) |

### Continuous Run:

Start (SLS2) - End cap on left side:

Middle (SLS3) - No end caps

End (SLS4) - End cap on right side

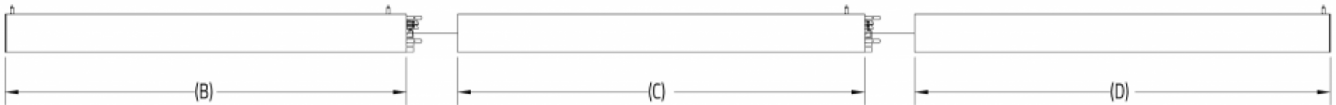

## Indirect Sections

HS0-HE0:

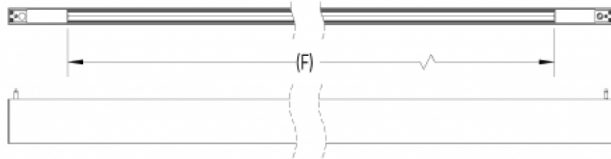

HS2-HE0:

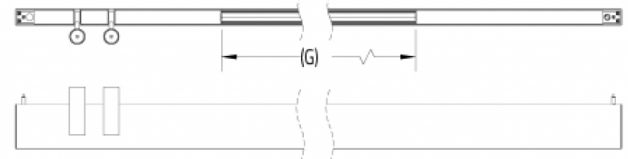

HS0-HE2:

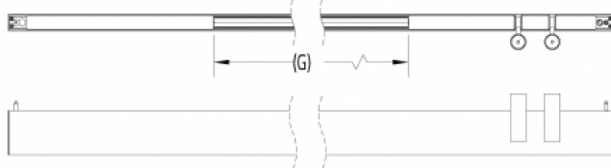

HS2-HE2:

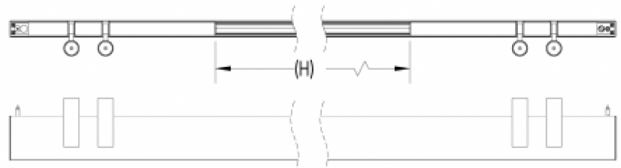

### Indirect Light Length:

| Fixture Size: | (F)             |
|---------------|-----------------|
| 4' [SL04]     | 36.7" (932mm)   |
| 6' [SL06]     | 60.3" (1532mm)  |
| 8' [SL08]     | 84.2" (2139mm)  |
| 10' [SL10]    | 108.2" (2748mm) |
| 12' [SL12]    | 120.2" (3053mm) |

# Rodeo Solo™ - Dimensional Diagrams

Canopy

## Hard Ceiling [H1]:

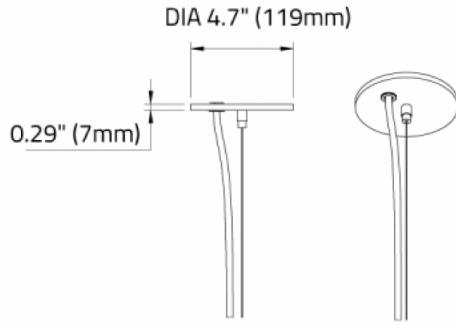

## Grid Ceiling [G1]:

