

# BLOCK™ - Dimensional Diagrams

## Block 1.5/2.5/3.5" - Dimensional Diagrams

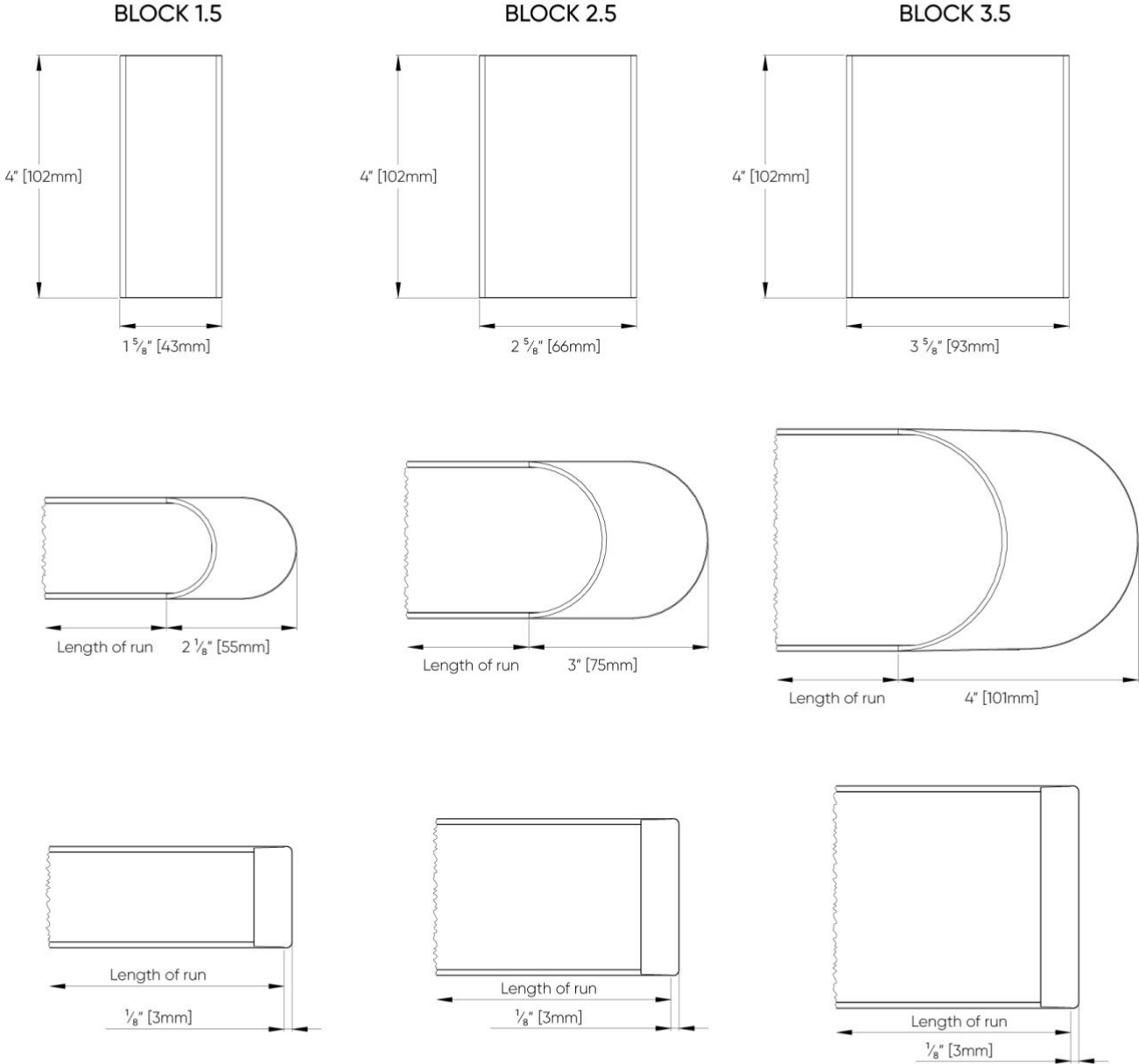

# BLOCK™ - Dimensional Diagrams

## PENDANT

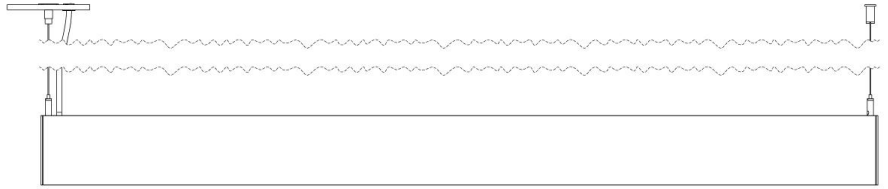
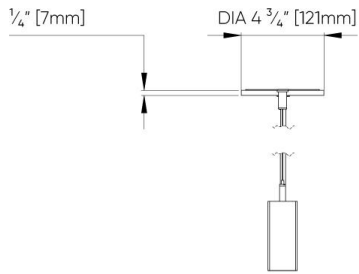

## SURFACE

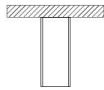

## WALL

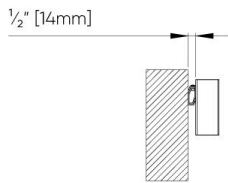

## RECESSED - Grid Ceiling

### Tegular ceiling

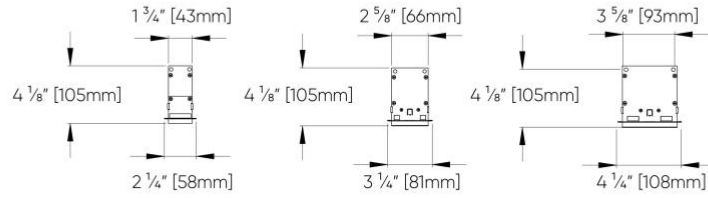
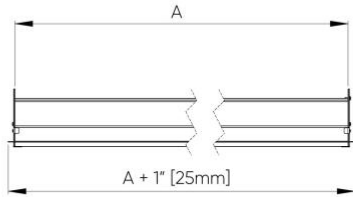

### T-bar ceiling

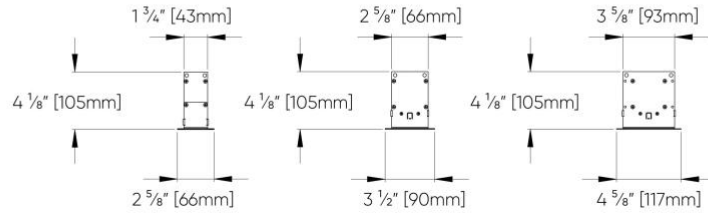
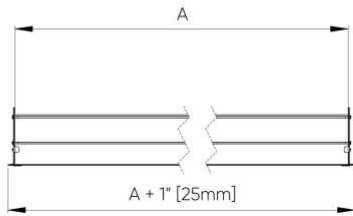

GRID CEILING	
Max Length (Per Section)	A
4ft	46 3/4" [1186mm]
6ft	70 3/4" [1796mm]
8ft	94 3/4" [2405mm]
10ft	118 3/4" [3015mm]
12ft	142 3/4" [3625mm]

## RECESSED - Hard Ceiling

### Trimless

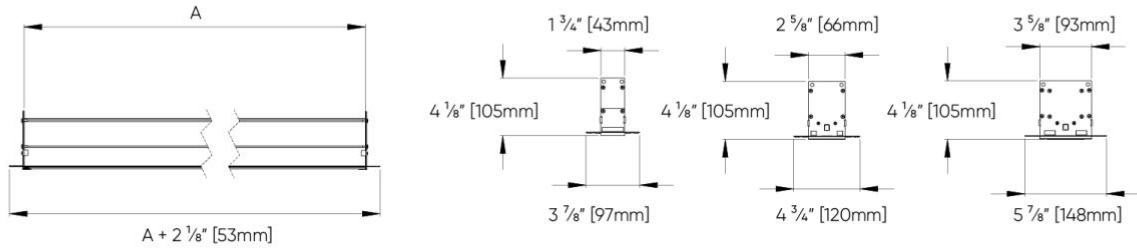

### Trim

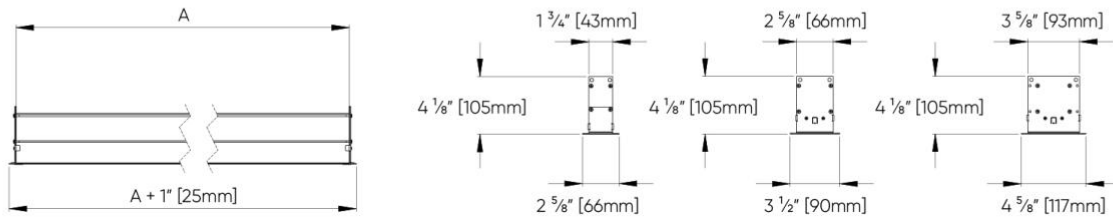

HARD CEILING	
Max Length (Per Section)	A
4ft	48" [1219mm]
6ft	72" [1829mm]
8ft	96" [2438mm]
10ft	120" [3048mm]
12ft	144" [3658mm]

WALL MOUNT CONFIGURATIONS

**4FT**

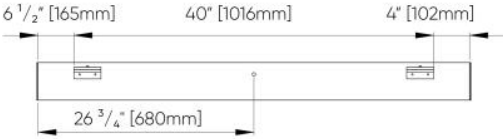

**6FT**



**8FT**

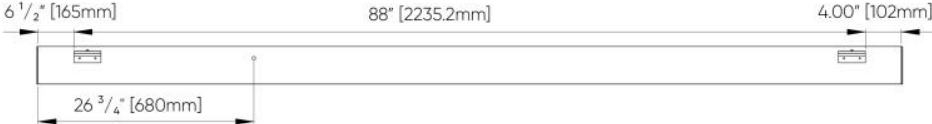

**10FT**

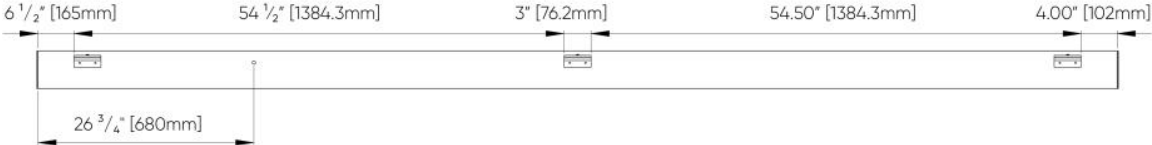

**12FT**

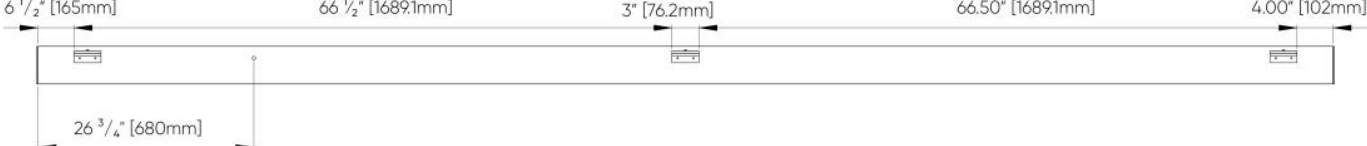

## Block 1.5/2.5/3.5" Systems - Dimensional Diagrams

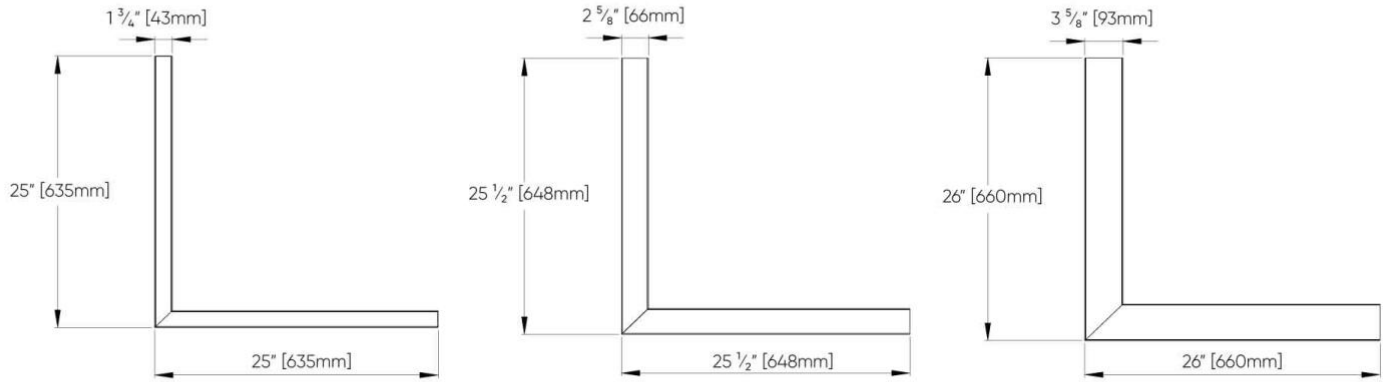

## Run Type

