













Luminaire-Level Lighting Controls

Integrated controls solutions for smarter, more dynamic lighting environments



Connected Controls

		Cooper WaveLinx PRO Product code: OEM-WAA Description: Cooper Wavelinx Pro wireless occupancy/daylight sensor & controller	Spec Link
		Legrand Wattstopper Product code: LMFS-601 Description: Wattstopper wireless occupancy/daylight sensor & controller	Spec Link
		Legrand Wattstopper PLUS Product code: ZBHA-CLM-DIM Description: Wattstopper Plus integral wireless controller	Spec Link
		Legrand Wattstopper PLUS Product code: EN-CLM-PIR-DD-ZB Description: Wattstopper Plus integral wireless occupancy/daylight sensor & controller	Spec Link
		Lutron Athena Product code: A-WN-D01-OCC-WH / A-WN-D01-RF-WH Description: Lutron Athena integral wireless RF controller / Lutron Athena integral wireless occupancy/daylight sensor & controller	Spec Link
		Lutron Vive Product code: DFCSJ-OEM-OCC / DFCSJ-OEM-RF Description: Lutron Vive integral wireless RF controller / Lutron Vive integral wireless occupancy/daylight sensor & controller	Spec Link

Standalone Controls



Legrand Wattstopper
Product code: FS-205
Description: Standalone Occupancy Sensor

[Spec Link](#)



Legrand Wattstopper
Product code: FD-301
Description: Standalone Daylight Sensor

[Spec Link](#)

Sensor and Controller Mounting Diagrams

BLOCK 2.5 Embedded Controller Node Diagram

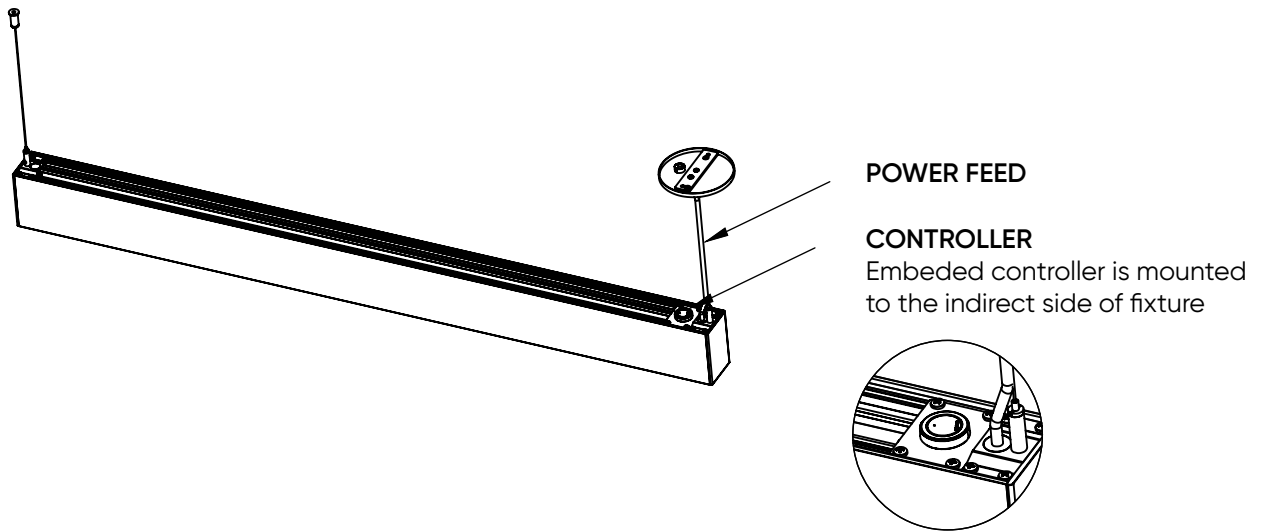

BLOCK 2.5 Embedded Sensor Node Diagram

