



GENERAL SPECIFICATION

Body: Aluminum.

Finish: Powder coated.

Suspension: Stainless steel cables.

Power cable: Silver braided.

Diffuser: Protruding Lens (2.1mm/0.08").

Drivers: HPF electronic drivers for 120-277V (EU-240V), 0-10V, 1% dimming.

Remote Mounting Of Drivers: Wire Size 18 AWG - Max distance (from canopy to drivers) 9.5', Wire size 16 AWG - Max distance 19.5', Wire size 14 AWG - Max distance 29.5'. Drivers must be accessible after installation.

Remote Emergency: Emergency option provides a 1.5 hour (3 hours for EU) emergency lighting facility. The remote system includes the inverter module, NiCad batteries and a remote wall/ceiling LED charge indicator and test switch (NA only) Maximum distance between wall/ceiling plate and luminaire is 4.5m/15'. Test switch fits a single gang box (not supplied).

L70 @25deg C: >50,000 hrs.

Mechanical: Luminaires mount directly over J box (by others - North America only).

Delivered Lumens: Delivered lumens & LPW based on 3000K (min 80 CRI) for White LEDs only.

MOUNTING & OPTICS



Suspended Direct

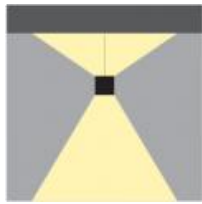

Suspended Direct/Indirect

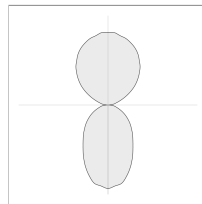

95 8110

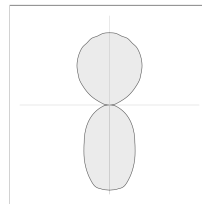

95 8120

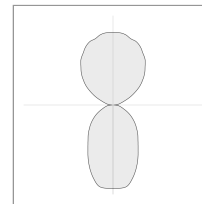

95 8130

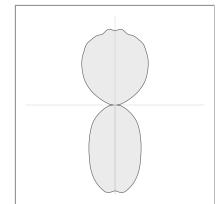

95 8140

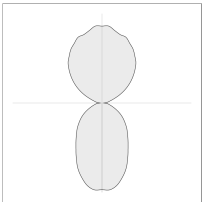

95 8150

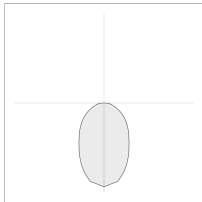

95 8010

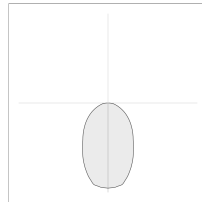

95 8020

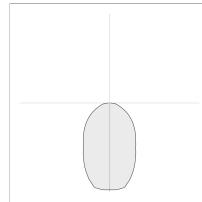

95 8030

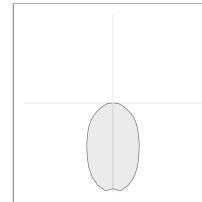

95 8040

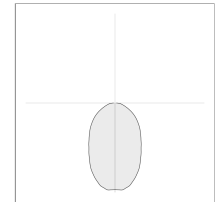

95 8050

HOW TO ORDER

A SPECIFY LUMINAIRE

Code:	Diameter (A):	Light Direction:	Power:	Delivered lms:	LPW:	# of Sections:	Suspension Points:
95 8010	914mm/36"	Direct	39W	2691	69	1	3
95 8020	1219mm/48"	Direct	50W	3450	69	1	3
95 8030	1524mm/60"	Direct	68W	4665	69	1	3
95 8040	1829mm/72"	Direct	80W	5211	69	1	4
95 8050	2134mm/84"	Direct	95W	6517	69	1	4
95 8110	914mm/36"	Direct/Indirect	80W	6007	75	1	3
95 8120	1219mm/48"	Direct/Indirect	108W	8100	75	1	3
95 8130	1524mm/60"	Direct/Indirect	135W	10057	75	1	3
95 8140	1829mm/72"	Direct/Indirect	160W	11994	75	1	4
95 8150	2134mm/84"	Direct/Indirect	190W	12009	75	1	4

B SPECIFY CCT/COLOR (DIRECT)

D30	3000K (min 80 CR)
D35	3500K (min 80 CR)
D40	4000K (min 80 CR)
DRD	Red
DGN	Green
DBL	Blue

C SPECIFY CCT/COLOR (INDIRECT)

N30	3000K (min 80 CR)
N35	3500K (min 80 CR)
N40	4000K (min 80 CR)
NRD	Red
NGN	Green
NBL	Blue

D SPECIFY SUSPENSION

S1	Vertical, Remote Driver (2 canopies required for 2134mm/84" dia. only)
S2	Hub Remote Driver
S3	Vertical Integral Driver
S4	Hub Integral Driver

Additional Information

Direct Only light distribution not available with S2 or S4 suspension for size 2134mm/84"

Direct/Indirect light distribution not available with S2, S3 or S4 suspension for sizes 1524mm/60" and larger

E SPECIFY FINISH

BL	Black
MS	Metallic Silver
WH	White

F SPECIFY LUMEN REDUCTION

- PR1** Lumen Reduction to approximately 50% of standard output
- PR2** Lumen Reduction to approximately 75% of standard output

G SPECIFY DIMMING

- DR** DALI Dimming (1%) Remote only (EU only)

Additional Information

Not available in North America

H SPECIFY OPTIONS

- RE** Remote Emergency System

EXAMPLE SPECIFICATION CODE

958110/35/NRD/S1/WH

DIMENSIONAL DIAGRAMS

S1 VERTICAL REMOTE DRIVER

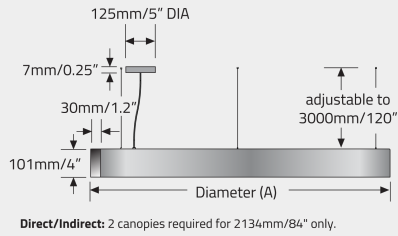

S2 HUB REMOTE DRIVER

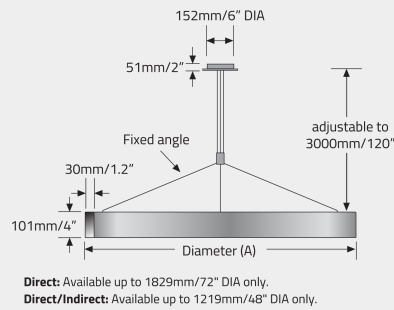

S3 VERTICAL INTEGRAL DRIVER

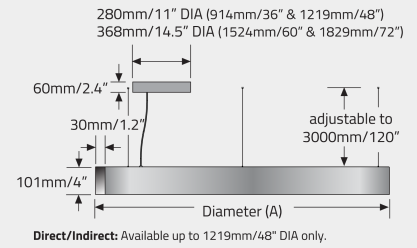

S4 HUB INTEGRAL DRIVER

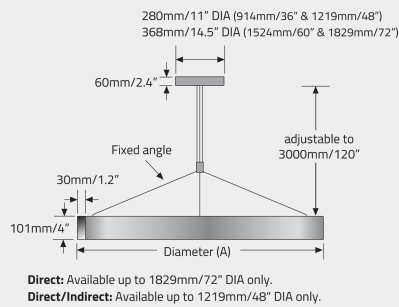

APPROVALS

