



GENERAL SPECIFICATION

Body and trim: Steel and aluminium (extruded).

Array housings: Die cast aluminium.

Gimbal: Fully articulating on two axes.

Suspension: Two cables, fully adjustable.

Reflectors: Highly reflective, specular finish, vacuum plated.

Protective lens: Clear glass.

Power cable: Silver braided.

Finish: Silver Metallic powder coated.

Drivers: HPF electronic for 120-277V (EU-240V), 0-10V dimming (10%) standard.

L70 @25deg C (77deg F): > 60,000 hrs.

Delivered Lumens: Delivered lumens & LPW based on 3000K (min 80 CRI), Opal diffuser.

Approvals: Damp Location (Indoor use only).

Note: Photometric testing performed using LM79 procedures.



MOUNTING & OPTICS

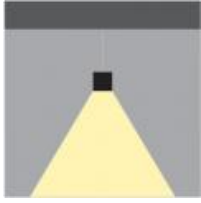

Suspended Direct

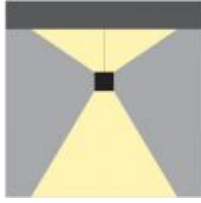

Suspended Direct/Indirect

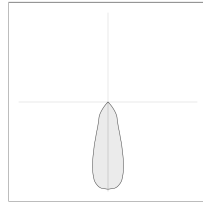

26W-SINGLE HEAD-ME-36 DEG

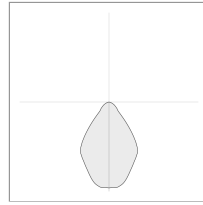

26W-SINGLE HEAD-XW-70 DEG

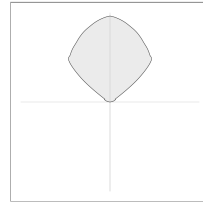

40W-INDIRECT ONLY

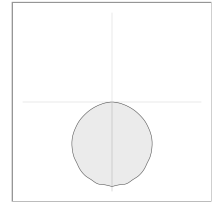

40W-OPAL DIRECT ONLY

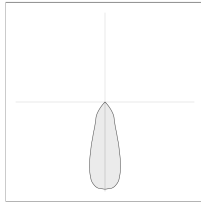

26W-SINGLE HEAD-ME-36 DEG

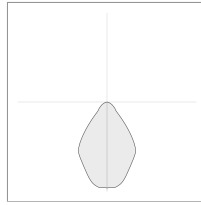

26W-SINGLE HEAD-XW-70 DEG

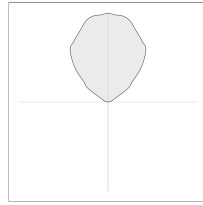

80W-INDIRECT ONLY

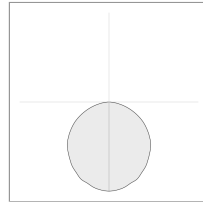

80W-OPAL DIRECT ONLY

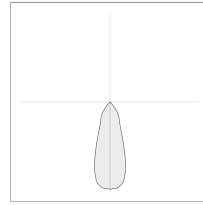

26W-SINGLE HEAD-ME-36 DEG

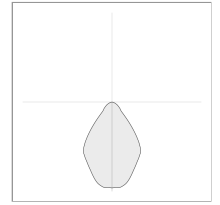

26W-SINGLE HEAD-XW-70 DEG

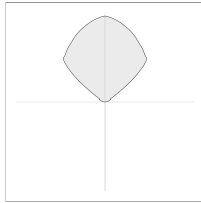

40W-INDIRECT ONLY

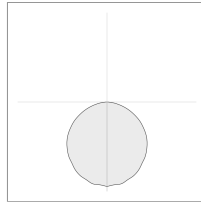

40W OPAL DIRECT ONLY

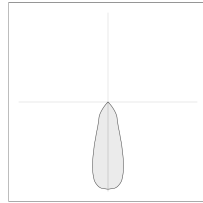

26W-SINGLE HEAD-ME-36 DEG

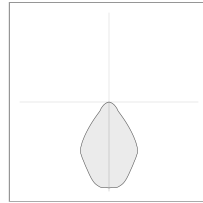

26W-SINGLE HEAD-XW-70 DEG

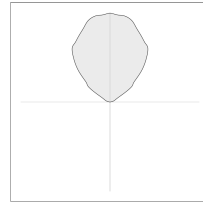

80W-INDIRECT ONLY

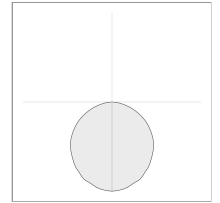

80W-OPAL DIRECT ONLY

HOW TO ORDER

A SPECIFY LUMINAIRE

Code	Power (LED)	Type	Delivered lms	LPW	Indirect lms	Indirect LPW
50 1850	(2 x 26) & 40W	A	(2 x 2085) + 5084	101	(2 x 2085) + 5762	108
50 1855	(2 x 26) & 80W	A	(2 x 2085) + 10028	108	(2 x 2085) + 11441	118
50 1860	(4 x 26) & 40W	B	(4 x 2085) + 5084	93	(4 x 2085) + 5762	98
50 1865	(4 x 26) & 80W	B	(4 x 2085) + 10028	100	(4 x 2085) + 11441	100

B SPECIFY CRI

30	3000K (min 80 CRI)
35	3500K (min 80 CRI)
40	4000K (min 80 CRI)

C SPECIFY SPOTLIGHT REFLECTORS

ME	Medium 36°
XW	Extra Wide 70°

D SPECIFY LED MODULE

IN	Indirect Only
OP	Opal Diffuser (Direct only)

E SPECIFY OPTIONS

SS	Separate Switching
----	--------------------

EXAMPLE CODE

501850/35/ME/IN

DIMENSIONAL DIAGRAMS

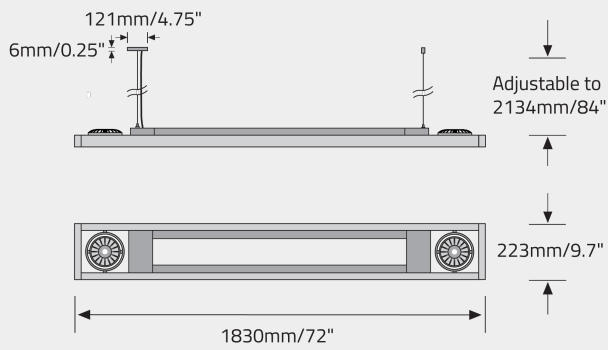

TYPE A

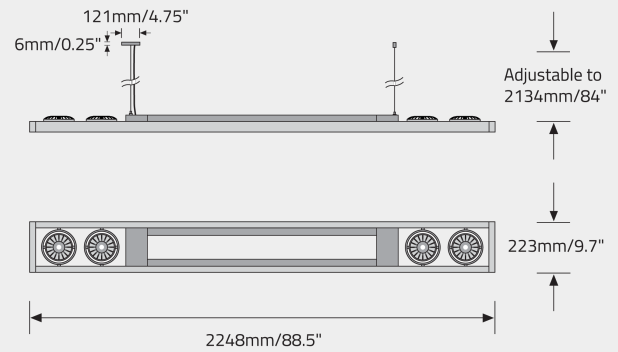

TYPE B

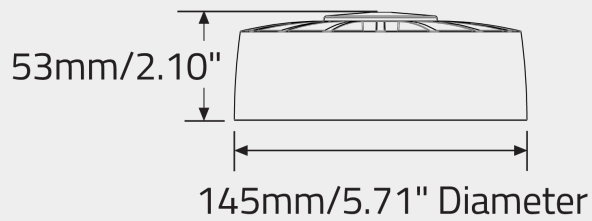

APPROVALS

