

0000H™ - CONTINUOUS

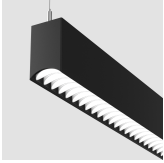

Project Name:

Fixture Type:

Fixture Code:

Quantities:

A. LUMINAIRE

HLNL1P Direct

HLNL2P Direct/Indirect

One power cord for every 50 linear feet.

B. LENGTH OF RUN

SFA _ _ _ _

The minimum length of order is 4ft. Lengths are to be in 2ft increments.

Example: 4ft = SFA0400

Example: 10ft = SFA1000

Example: 50ft = SFA5000

For runs over 50ft in length, consult factory.

C. MAX LENGTH PER SECTION

SL04 4ft

SL06 6ft

SL08 8ft

SL10 10ft

SL12 12ft

You can select the preferred maximum length per segment, to account for transportation and building constraints. Example: If a 40ft run is required and SL12 (12ft) is selected, we would provide 4 10ft segments. For special requirements, please contact sales@betacalco.com.

D. LOUVER

LV2 Black

LV3 White

LV4 Satin Chrome

LV6 Satin Gold

LV9 Satin Champagne

E. LM/FT (DIRECT)

LPF020 200 lm/ft

LPF030 300 lm/ft

LPF040 400 lm/ft

LPF050 500 lm/ft

LPF060 600 lm/ft

LPF070 700 lm/ft

LPF080 800 lm/ft

LPF100 1000 lm/ft

LPF120 1200 lm/ft

LPF130 1300 lm/ft

Lumens/ft are determined by the color of the Louver. Consult website for available lumens/ft based on selected louver.

F. LM/FT (INDIRECT)

LPG000 Not required

LPG020 200 lm/ft

LPG040 400 lm/ft

LPG060 600 lm/ft

LPG080 800 lm/ft

LPG100 1000 lm/ft

LPG120 1200 lm/ft

LPG140 1400 lm/ft

LPG165 1650 lm/ft

Consult website for available lumens/ft.

G. CRI

CR80 CRI 80+

CR90 CRI 90+

H. CCT DIRECT

CTA30 3000K

CTA35 3500K

CTA40 4000K



0000H™ - CONTINUOUS

I. CCT INDIRECT

CTB00 Not required

CTB30 3000K

CTB35 3500K

CTB40 4000K

J. DIRECT DIFFUSER

DD1 Asymmetric diffuser

DD4 Comfort Diffuser

¹ When standing at the end view of the profile on the side where the power cord is installed, the asymmetric beam will aim to the right.

K. UPLIGHT DIFFUSER

UDO Not required

UD1 Clear diffuser (Batwing distribution) **UD3** Asymmetric diffuser ¹

¹ Available up to 1200 lm/ft.

L. UPLIGHT BLACKOUT PLATE

UB00 Not required

UB_ _ Blackout plate ¹

¹ Available on a per foot basis. May be required to prevent lighting up duct work in a loft type application.

M. VOLTAGE

V1 120/277V

V2 240V ¹

V3 347V ²

V4 Low Voltage ³

¹ Not available in North America.

² Only available with DA01 dimming.

³ Only available with DA45 dimming.

N. DIMMING

DA01 0-10V Dimming 1.0%

DA02 0-10V Dimming 0.1% ¹

DA20 DALI Dimming 0.1% ¹

DA21 DALI Dimming 1.0% ¹

DA30 DSI/switchDim ²

DA45 PoE ³

¹ Not available with V3.

² Not available in North America.

³ Only available with V4.

O. CEILING TYPE

G1 Grid ceiling ¹

H1 Hard ceiling ²

The cost for the canopies, power cables, connections mechanisms and endcaps for the fixture has been added to these items.

¹ Combo kit provided includes installation to T-bar and through tile mount.

² Designed for drywall ceilings.

P. SUSPENSION

HLA03 3ft cable suspension

HLA06 6ft cable suspension

HLA09 9ft cable suspension

Q. FIXTURE FINISH

FA01 White - Textured

FA02 Black Metallic - Textured

FA20 Silver Metallic - Textured

FA25 Gold Metallic - Textured

FA27 Wood grain - Light Cherry ¹

FA28 Wood grain - Dark Walnut ¹

FA44 Midnight Blue Metallic - Textured

FA45 Copper Metallic

FA46 Charcoal Metallic - Textured

FA47 Bronze Metallic - Textured

FA52 Champagne Metallic

FA53 Red Metallic - Textured

¹ Longer than normal lead times may apply, consult factory.



0000H™ - CONTINUOUS

R. CANOPY FINISH

CF01 White

CF02 Black Metallic - Textured

CF20 Silver Metallic - Textured

CF25 Gold Metallic - Textured

CF44 Midnight Blue Metallic - Textured

CF45 Copper Metallic

CF46 Charcoal Metallic - Textured

CF47 Bronze Metallic - Textured

CF52 Champagne Metallic

CF53 Red Metallic - Textured

S. EMERGENCY

E0 Not required

E1 Emergency system - Integral ¹

E3 Emergency generator circuit ¹

¹ A drawing will be required at time of ordering to determine the required number and location of the emergency sections or generator circuits. Not available in 347V.

T. CIRCUITS

CS1 Single circuit

CS2 Dual circuit ¹

¹ Independent control of upright for HLNP2P.

U. SENSORS



0000H™ - CONTINUOUS

DIMENSIONAL DIAGRAMS

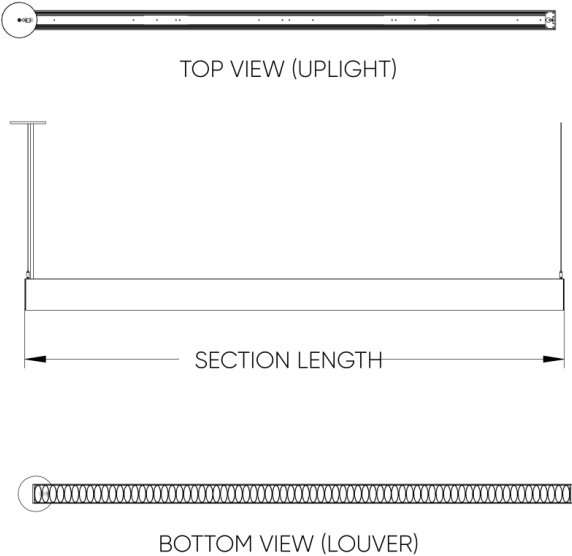
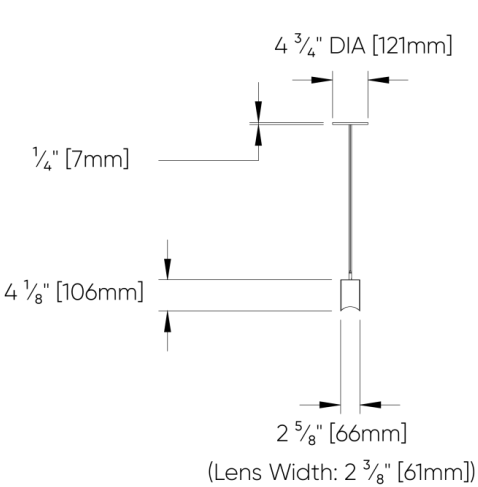
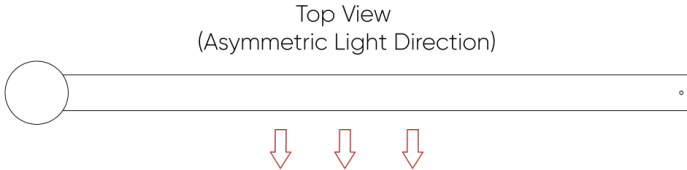
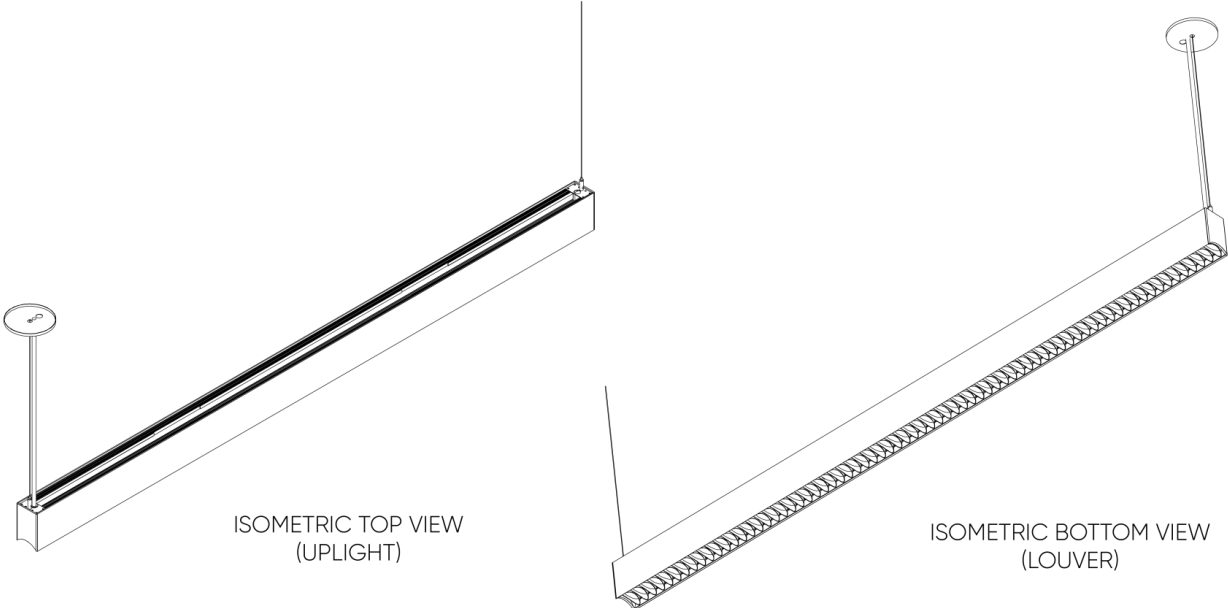

0000H™ - CONTINUOUS

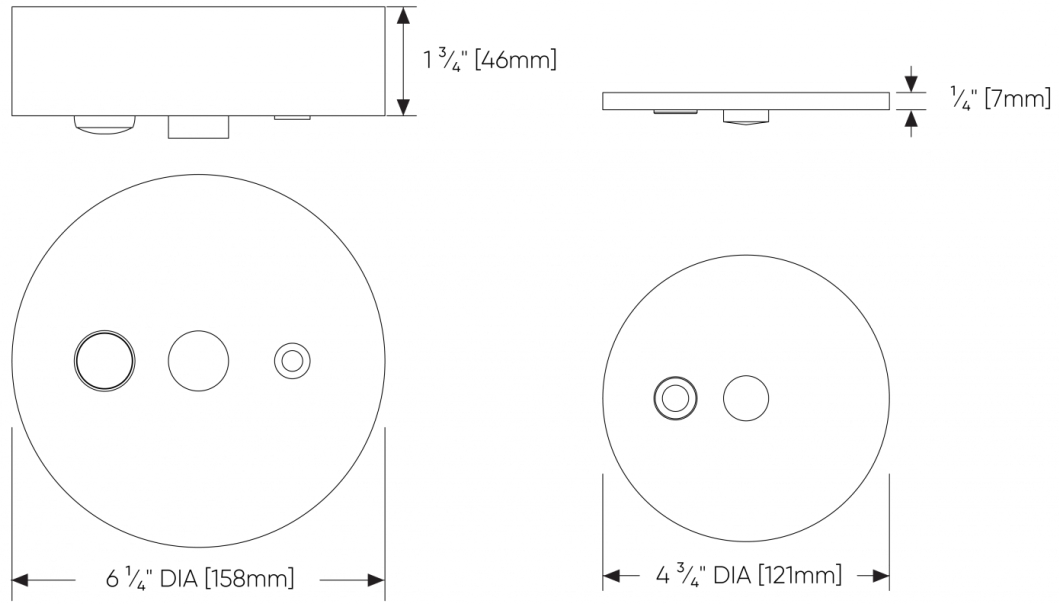

Canopy with Sensor

Standard Canopy